

end panel box

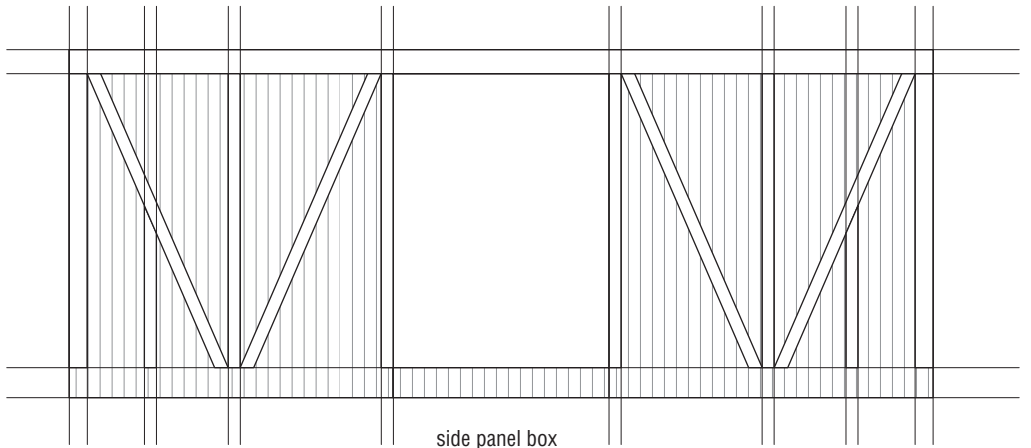

side panel box

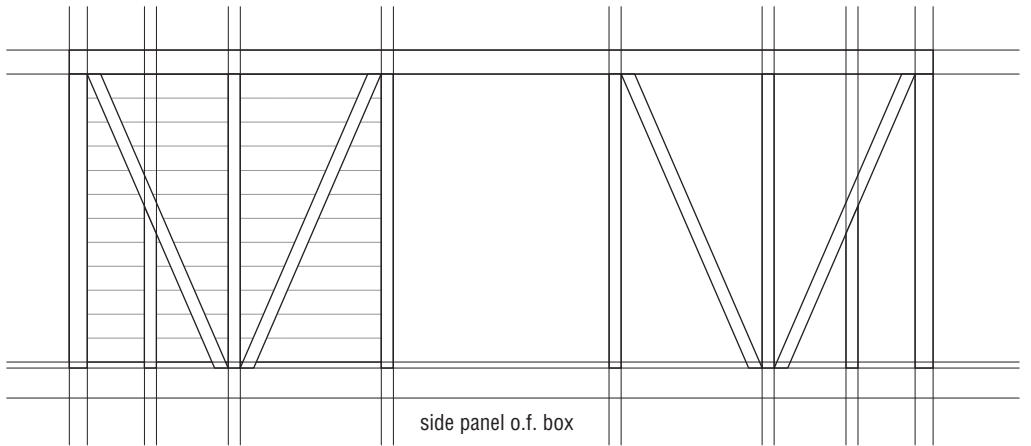

side panel o.f. box

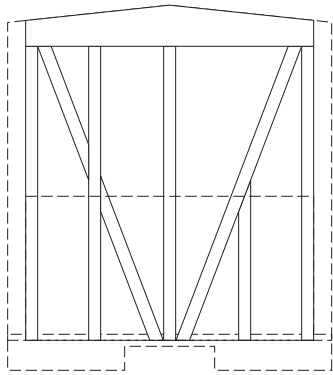

end frame box

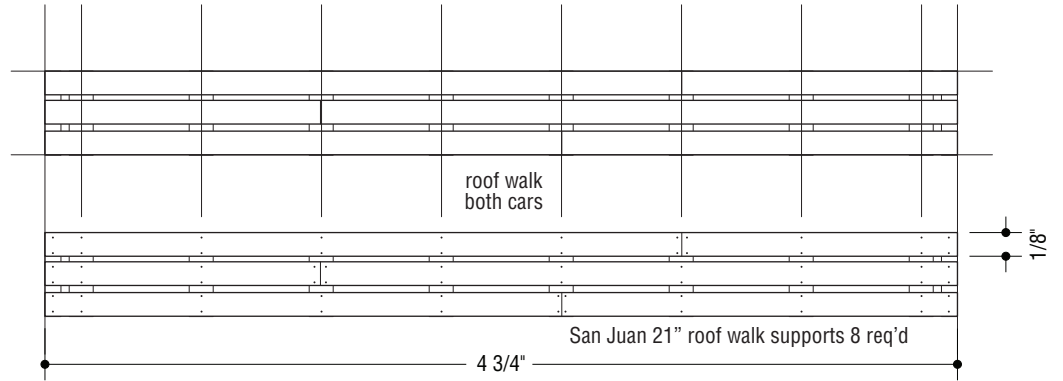

roof walk  
both cars

San Juan 21" roof walk supports 8 req'd

4 3/4"

1/8"

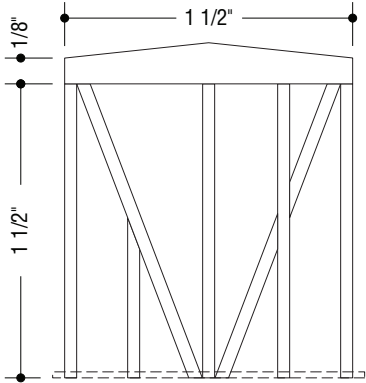

end frame o.f. box

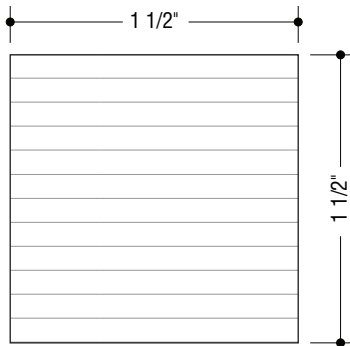

inside panel o.f. box  
make 2

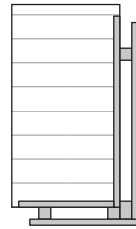

typ. corner box

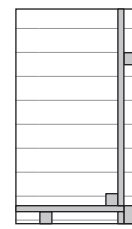

typ. corner o.f. box

# Sweet Haven Railroad boxcar build addendum 1

scale 1/4" = 1'-0" (full size for On30)

